

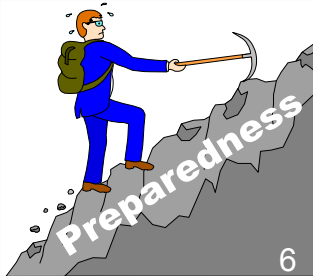

# UTILITIES

*When disaster strikes, it often affects one or more of the utility systems in our homes. It is important to know where the main controls are located and when and how to turn them off. Learn these things before disaster strikes!*



6

**Taking it one step at a time.**

**ELECTRICITY** - A disaster can disrupt your electrical service or cause wires and electrical fixtures to separate, creating a shock and fire hazard:



Before a disaster occurs:

- ↓ Locate your main electrical panel or fuse box. Usually it's on an interior wall near your electric meter.
- ↓ If your residence has a fuse box, maintain a supply of spare fuses of the correct amperage.
- ↓ Always keep a working flashlight available, with extra batteries of the correct size and type.

When you lose power, check the fuses and/or circuit breakers to be sure the trouble is not in your household electric system.

- ↓ **Turn off** all electrical equipment (e.g., water heater, electric furnace, heaters, stove, washer, dryer, TV) to prevent system overload when the power is restored.
- ↓ **Turn on** a porch light and one inside light so you and utility crews will know when service is restored.
- ↓ If you have to step in water to get to the fuse box or circuit breaker, call an electrician first for advice.
- ↓ If a generator is used as backup power supply, remember to follow the manufacturer's instructions. Connect lights and appliances directly to the generator and not the electrical system.

If you see sparks or broken/frayed wires or if you smell hot insulation, shut off your electricity immediately.

- ↓ For a circuit breaker panel - Shut off the electricity by turning all circuit breaker switches to the "off" position.
- ↓ For a fuse box, pull out the two main (cartridge) fuses.

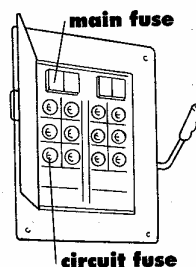

**Fuse Boxes**

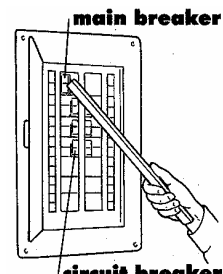

**Breaker Boxes**

**NATURAL GAS** - Any odor of natural gas inside your home might indicate a leak. If you smell natural gas or hear blowing or a hissing noise, open a window and quickly leave the building. Turn off your gas at the meter as soon as possible:

- ↓ Locate the shut-off valve.
- ↓ Use a crescent wrench and turn the rectangular nob one quarter turn clockwise to the horizontal position.
- ↓ Call your gas company from a neighbor's home.

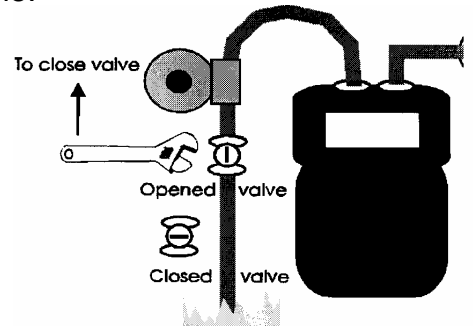

↓ If you turn off the gas for any reason, service should be performed by a professional ***if you suspect a gas leak:***

***DON'T*** use a mobile phone, which includes cellular phones and all types of portable communication and electronic devices that have a battery. These can spark and create a source of ignition.

***DON'T*** use matches, lighters, or open flame appliances and don't operate electrical switches.

**WATER** - Earthquakes and freezing weather can rupture water pipes, causing flooding if not turned off quickly. Find the location of your home's shut off valve.

- ↓ There is a shut off valve at the water meter, but there may also be one closer to your house.
- ↓ Some common places to look for your master shut off valve are:
  - In the crawl space or basement where the water line enters the house.
  - In the garage where the water line enters the wall or ceiling, near the water heater, or by the clothes washer hookup.
  - Outside, near the foundations of your home, possibly protected by a concrete or clay pipe ring.

*If you don't find a hand-operated master shut off valve, have one installed on the house side of the meter. It may come in handy.*

**Water Meter**

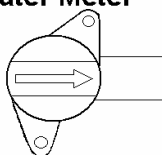

**Open / On**

**Water Meter**

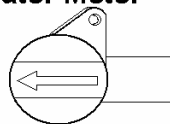

**Closed / Off**

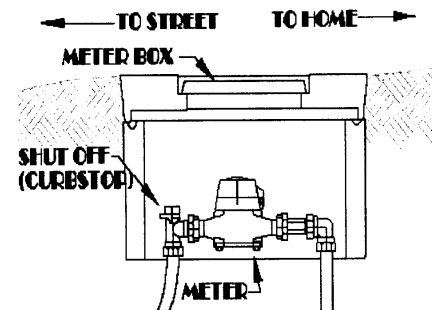

*Your sewer system could also be damaged in a disaster such as an earthquake, landslide, or flood. Make sure the system is functioning as designed before using it. This may prevent the contamination of your home and possibly your drinking water supply.*